



Roasters
Vertical Spiral Conveyors
**Modular Belt
Conveyors**
Fryers
Cooling & Proofing
Wire Belt Conveyors
Tunnel Ovens

Conveyor Components for the Bakery Industry



www.pobcoplastics.com

POBCO Sanitary Guide Rails for Modular Belt

Materials: Natural UHMW or Plus (Lube-Filled UHMW)

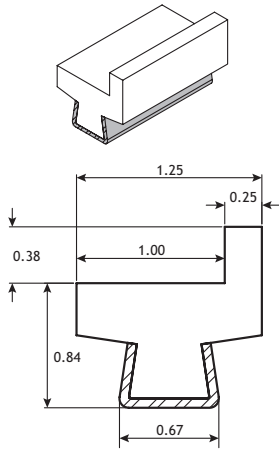

GRA-B/C
UHMW/SS

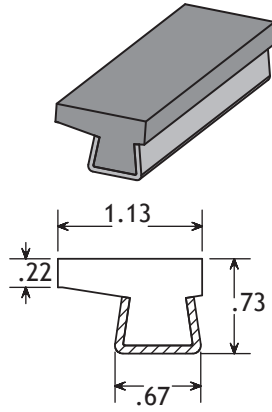

GRA1.125B/CPLUS
PLUS/SS

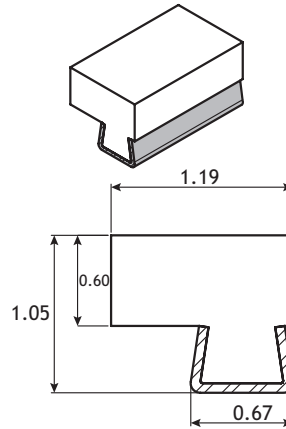

GRA-1.19 B/C
UHMW/SS

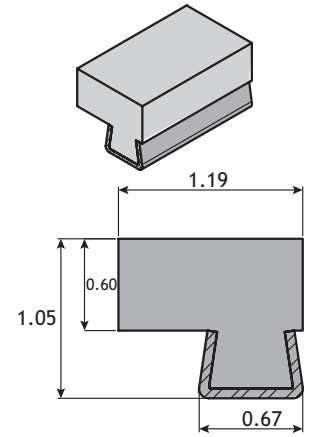

GRA-1.19 B/CPLUS
PLUS/SS

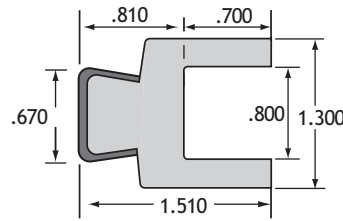
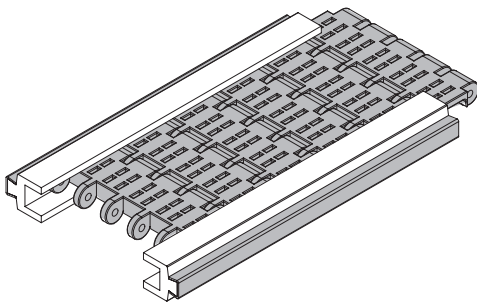

GRA2200Plus
(for Modular Belt)
PLUS/SS

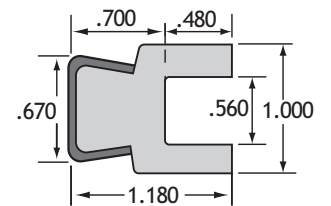

GRA2400Plus
(for Modular Belt)
PLUS/SS

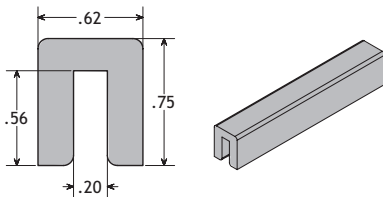

#CTP1210

Material: Plus

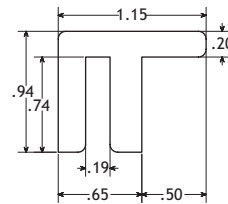

#CTU1518LEG

Material: UHMW

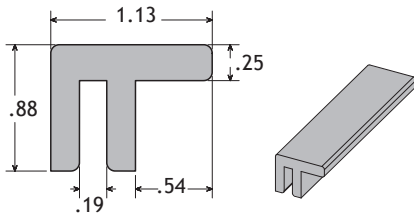

#CTP1518LEG

Material: Plus

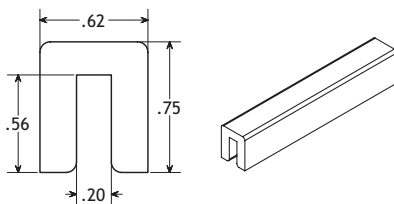
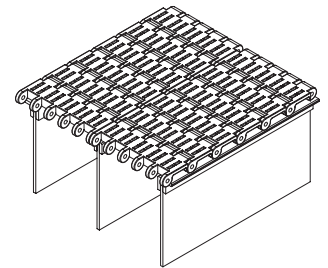
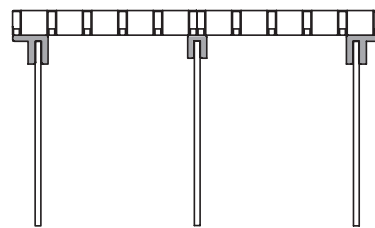

#CTU1210

Material: UHMW

POBCO Belt Guides

For 2200/2400 Series Belt. Offered in UHMW and Lube-Filled UHMW (POBCO Plus).

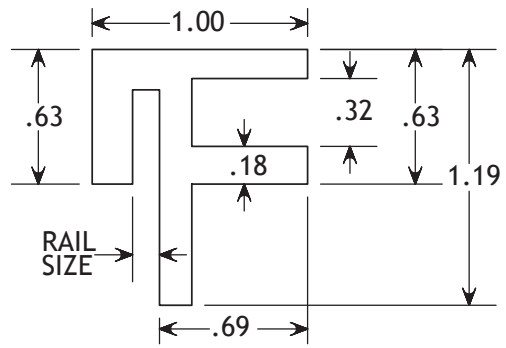
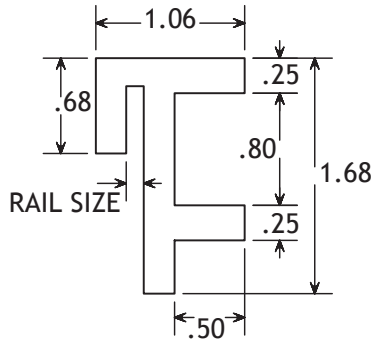

For 1/8" Thick Rail
FLUSH EDGE
CGU-021727 UHMW
CGP-021727 PLUS

For 3/16" Thick Rail
CGU-031727 UHMW
CGP-031727 PLUS

For 1/8" Thick Rail
TABBED EDGE
CGU-021619 UHMW
CGP-021619 PLUS

For 3/16" Thick Rail
CGU-031619 UHMW
CGP-031619 PLUS

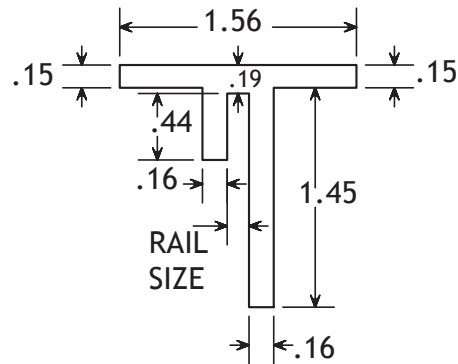
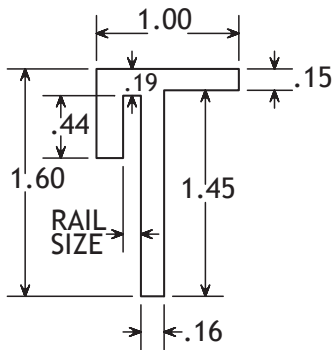

For 1/8" Thick Rail
ANGLE
CGU-021625 UHMW
CGP-021625 PLUS

For 3/16" Thick Rail
CGU-031625 UHMW
CGP-031625 PLUS

For 1/8" Thick Rail
CENTER RAIL
CGU-022525 UHMW
CGP-022525 PLUS

For 3/16" Thick Rail
CGU-032525 UHMW
CGP-032525 PLUS

POBCO Guide Angles & Channels

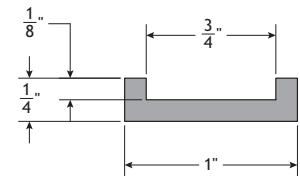
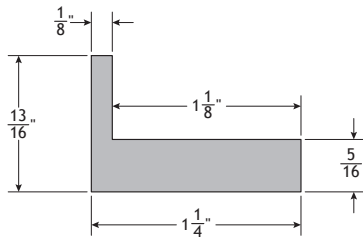
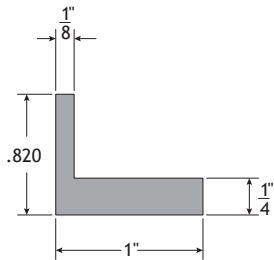

Plus (lube-filled) # GAP131604L120S

Plus (lube-filled) # GAP132002L120S

Plus (lube-filled) # CGP1202L120S

POBCO High-Temp Guide Rails

Material: POBLON (filled PTFE) with Stainless. Max (500° F) FDA Compliant

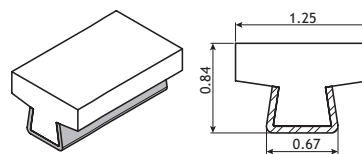
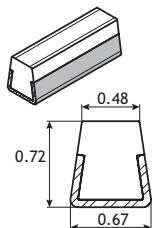

GRAFLATTM - POBLON/SS 10ft.

GRA1.25TTOPTM - POBLON/SS 10ft.

POBCO Bar Snap-Ons & Guide Rail Covers

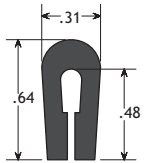

#BSG010709

Material: Nylon MD
Fits 1/16-3/32" Rail

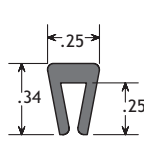

#BSP020404

Material: Plus
Fits 1/8" Rail

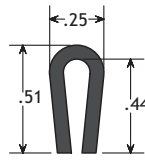

#BSG020708

Material: Nylon MD
Fits 1/8" Rail

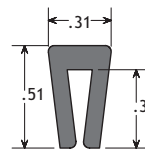

#BSP020609

Material: Plus
Fits 1/8" Rail

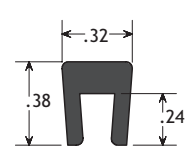

#BSG020306

Material: Nylon MD
Fits 1/8" Rail

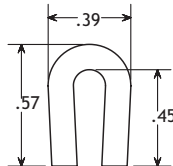

#BSN020709

Material: Nylon White
Fits 1/8" Rail

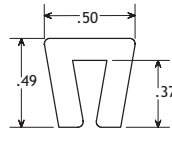

#BSU030608

Material: UHMW
Fits 3/16" Rail

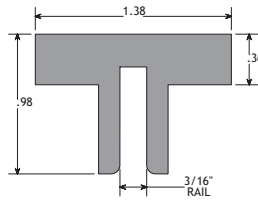

#BSP031315TTOP

Material: Plus
Fits 3/16" Rail

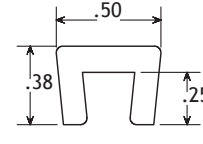

#BSU040406

Material: UHMW
Fits 1/4" Rail

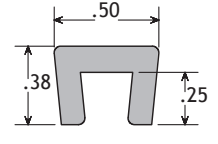

#BSP040406

Material: Plus
Fits 1/4" Rail

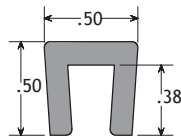

#BSP040608

Material: Plus
Fits 1/4" Rail

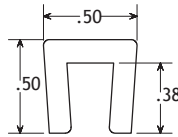

#BSU040608

Material: UHMW
Fits 1/4" Rail

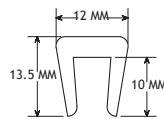

#BSU6MM10MM

Material: UHMW
Fits 6MM Rail

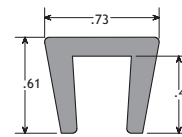

#BSP060810

Material: Plus
Fits 3/8" Rail

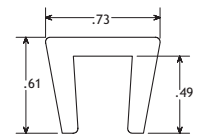

#BSU060810

Material: UHMW
Fits 3/8" Rail

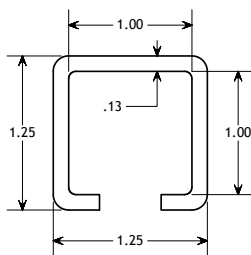

GRU161620

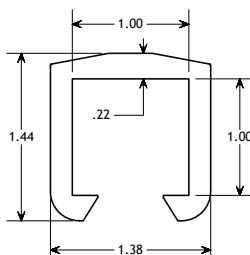

GRU161623

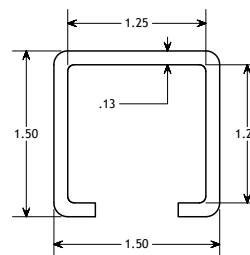

GRU202024

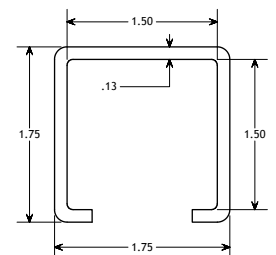

GRU242428

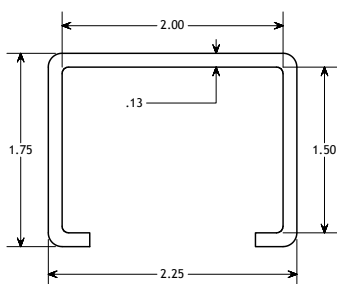

GRU243215

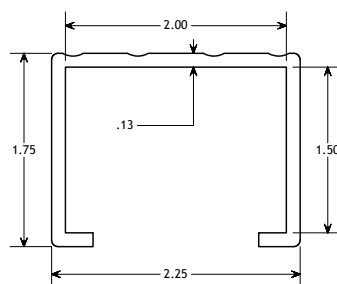

GRU243215RIB

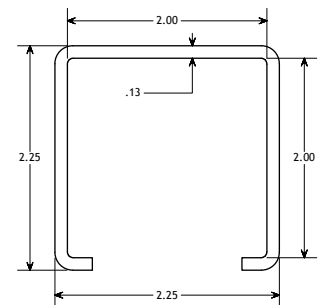

GRU323236

POBCO Flat Bar Clip-Ons

3/4" Wide

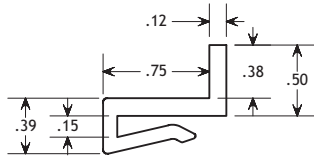

#FBU021402A3/8

Material: UHMW
Fits 1/8" Rail



#FBU021402A3/8B

Material: Blue UHMW
Color: Blue

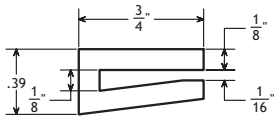

#FB12U011202

Material: UHMW
Fits 1/8" Rail



#FB12P011202

Material: Plus
Color: Grey

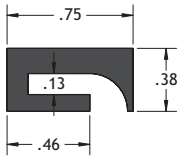

#FBU021206C100B

Material: UHMW Black
Fits 1/8" Rail

1" Wide

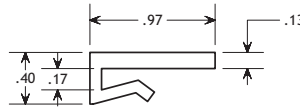

#FBU021602

Material: UHMW
Fits 1/8" Rail



#FBSRU021602

Material: Black Static Reduced UHMW
Color: Black

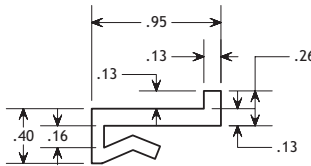

#FBU011602A1/8

Material: UHMW
Fits 1/8" Rail



#FBP011602A1/8

Material: Plus
Color: Grey

1-1/2" Wide

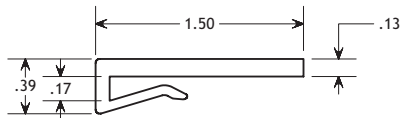

#FBU022402

Material: UHMW
Fits 1/8" Rail

3" Wide

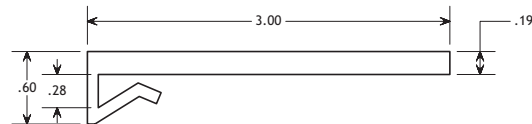

#FBU044803

Material: UHMW
Fits 3/16"-1/4" Rail

POBCO High Temperature Wear Strips

Materials:

- T = Virgin PTFE 450° maximum service temperature (FDA)
- GT = Glass Filled PTFE 500° maximum service temperature (not FDA)
- UH = High Temp Ultra-D 275° maximum service temperature (FDA)
- TM POBLON = 500° maximum service temperature (FDA)

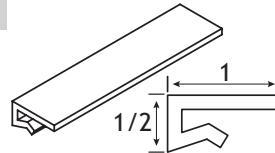

Flat Bar Clip On (Virgin PTFE)
Provides 1" protective cover for 1/8" to 1/4" thick rail. May require pinning.

Part # **FBT-031602**

PART NUMBER	A	B	C	D	FITS RAIL	STYLE
BST-020411 BSGT-020411	9/32"	11/32"	1/8"	1/4"	1/8" - .134" Thick	X Y
BST-040608 BSGT-040608 BSUH040608	1/2"	1/2"	1/4"	3/8"	1/4" Thick	X Y X
BST-060810 BSGT-060810 BSUH060810	3/4"	5/8"	3/8"	1/2"	3/8" Thick	X Y X

Style X

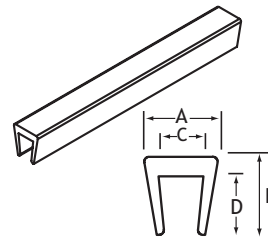

Style Y

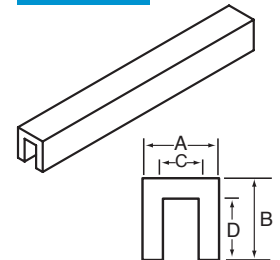



POBCO, Inc.
99 Hope Ave | Worcester, MA 01603
508.791.6376 | 1.800.222.6376
pobco@pobcoplastics.com | www.pobcoplastics.com